

Petri net models

Petri nets

Named after Carl Adam Petri who, in the early sixties, proposed a graphical and mathematical formalism suitable for the modeling and analysis of concurrent, asynchronous distributed systems.

Widely used for modeling biological systems (more than 130 publications in PubMed since 2002)

Simple form : a bipartite directed graph

two types of nodes:

- **places** represent conditions or resources (ex: phosphorylated histidine kinase)
- **transitions** represent activities, *i.e.*, events that can change the state of the resources (ex: synthesis)

directed **arcs** interconnect places and transitions

- places exclusively connected to transitions
- transitions exclusively connected to places

tokens placed on places define the state of the Petri net

An arc might be **weighted**: number of tokens that must be in the pre-place to enable the transition

Petri net models

Places are passive nodes. They are indicated by circles and refer to conditions or states. In a biological context, places may represent: populations, species, organisms, multicellular complexes, single cells, proteins (enzymes, receptors, transporters, etc.), molecules or ions. Only places are allowed to carry tokens.

Tokens are variable elements of a Petri net. They are indicated as dots or numbers within a place and represent the discrete value of a condition. Tokens are consumed and produced by transitions. In biological systems tokens refer to a concentration level or a discrete number of a species, *e.g.*, proteins, ions, organic and inorganic molecules. Tokens might also represent the value of physical quantities like temperature, pH value or membrane voltage that effect biological systems. A Petri net without any tokens is called “empty”. The initial marking affects many properties of a Petri net.

Petri net models

Transitions are active nodes and are depicted by squares. They describe state shifts, system events and activities in a network. In a biological context, transitions refer to (bio-) chemical reactions, molecular interactions or intramolecular changes. Transitions consume tokens from its pre-places and produce tokens within its post-places according to the arc weights.

Directed arcs are inactive elements and are visualized by arrows. They specify the causal relationships between transitions and places and indicate how the marking is changed by firing of a transition.

Thus, arcs define reactants/substrates and products of a (bio-)chemical reaction. Arcs connect only nodes of different types. Each arc is connected with an arc weight. The arc weight sets the number of tokens that are consumed or produced by a transition. The stoichiometry of a (bio-)chemical reaction can be represented by the arc weights.

Petri net models

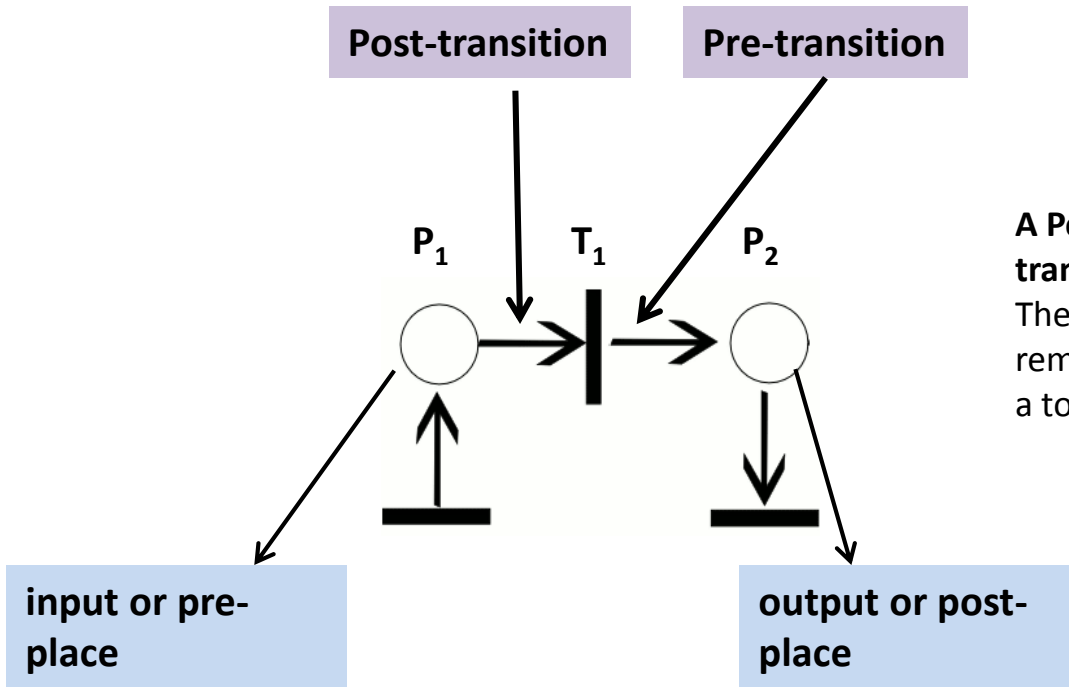



A Petri net with two places P_1 and P_2 et one transition T_1 .

The transition will be enabled and may fire by removing the tokens from the pre-place P_1 and adding a token to the post-place P_2 pointed by the transition.

Petri net models

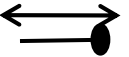
To enhance the expressiveness of Petri nets, two other types of arcs:

- **test arc (or read arcs)** (activates the transition, does not consume tokens) 
- **inhibitor arc** (inhibits the transition) 

A • Read Arc

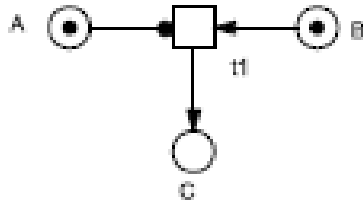

B • Inhibitor Arc

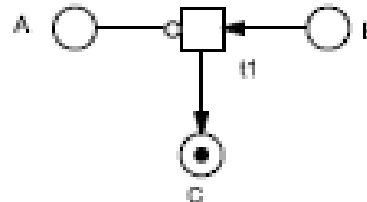
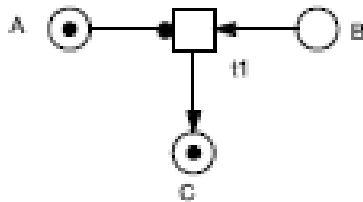
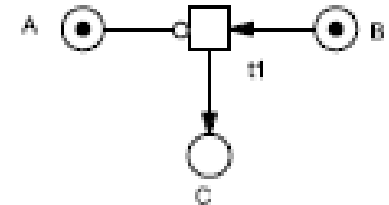
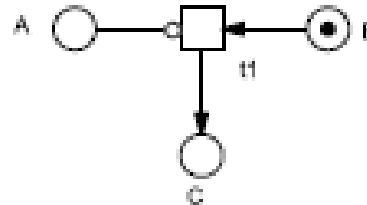

t_1 is enabled if places A and B are sufficiently marks. After firing, tokens are consumed from place B but not from place A .

t_1 is enabled if place B is sufficiently marks and place A insufficiently marked. After firing, tokens are consumed from place B

Petri net and biochemical networks

Standard Petri nets allow the representation of the essential components in biochemical pathways and they can be used to perform qualitative analysis (Reddy *et al.*, (1996) *Comput. Biol. Med.* **26**:9-24)).

Metabolic pathway = interconnection of networks of enzymatic reactions (product of one reaction is the a reactant (or an enzyme that catalyzes) a next reaction).

Petri net modeling of five type of reactions:

Places = reactants, products or enzymes

Transitions = reactions

Arc weights = stoichiometric coefficients of the reactions

Catalyzed reaction: the enzyme place is linked to the transition by a test arc

Inhibited reaction: the enzyme is linked to the transition by an inhibitory arc (the transition is enabled when the place is not marked)

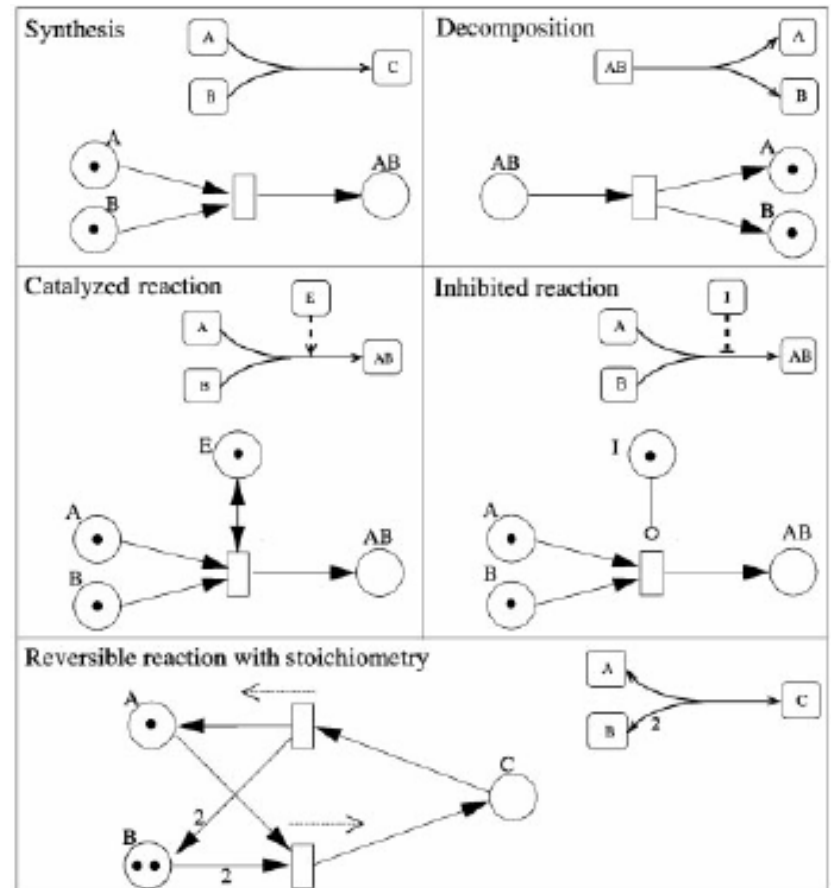

Petri net models

Firing a transition

- A transition is enabled to fire if all its pre-places are sufficiently marked, contain at least the required number of tokens defined by the weight assigned to the arcs.
- Results of the firing of an enabled transition: tokens of pre-places are consumed and new tokens are produced in its post-places. Their number are determined by the weight of the arcs going out of the transition.

Example: Pentose phosphate pathway

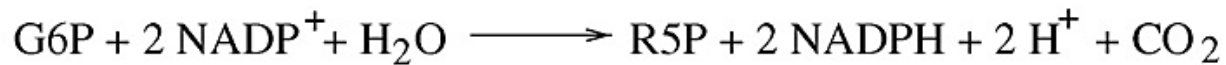
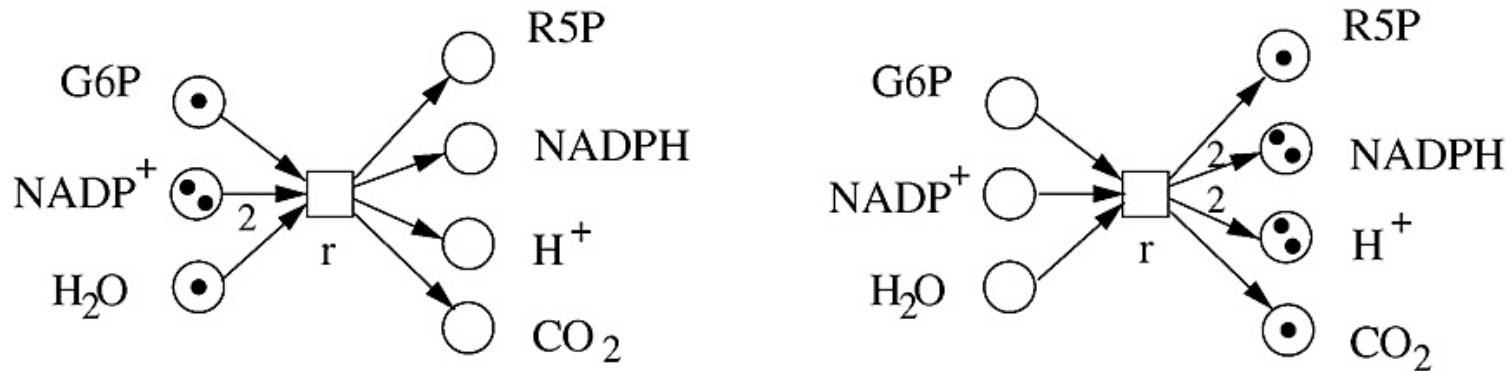

Grunwald *et al.*, 2008

The “token game” represents the dynamical evolution of the system

Petri net models

Initial marking M_0

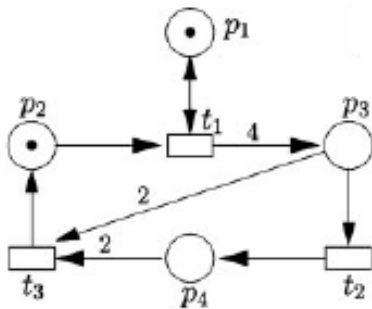

p_1 and t_1 are connected through a test arc that means that p_1 marking governs the enabling of t_1 but is not modified by the firing of t_1

new marking M_1

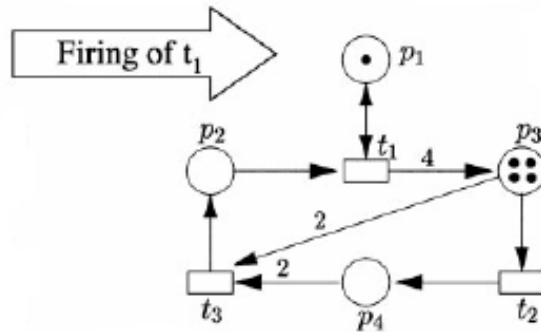

The token of p_2 is consumed.
Four tokens are produced in p_3 .
The new marking M_1 allows the firing of t_2

new marking M_2

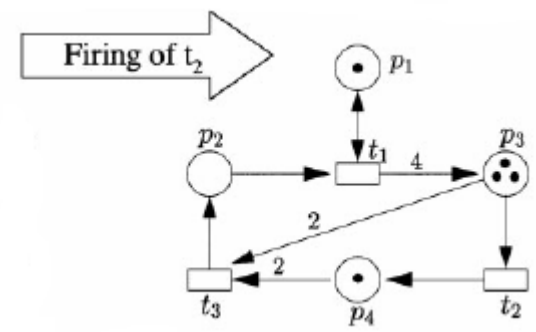

One token of p_3 is consumed.
One token is produced in p_4 .
The new marking M_2 does not allow the firing of t_3

Petri net models

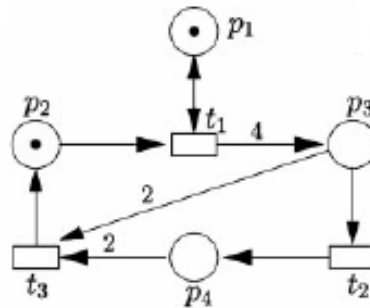

Algebraic description of a Petri net

a marking = a vector giving the number of tokens allocated to each place
 weighted arcs = definition of relation between a pre-place and a transition (preconditions)
 and between a transition and a post-place (postconditions) = Pre and Post matrices
 incidence matrix = for each transition, the balance of its firing onto each place (difference
 between the number of tokens produced and the number of tokens consumed)

initial marking

$$M_0 = \begin{bmatrix} 1 \\ 1 \\ 0 \\ 0 \end{bmatrix}$$

pre - condition matrix

	t_1	t_2	t_3
p_1	1	0	0
p_2	1	0	0
p_3	0	1	2
p_4	0	0	2

post - condition matrix

	t_1	t_2	t_3
p_1	1	0	0
p_2	0	0	1
p_3	4	0	0
p_4	0	1	0

incidence matrix

	t_1	t_2	t_3
p_1	0	0	0
p_2	-1	0	1
p_3	4	-1	-2
p_4	0	1	-2

$C = Post - Pre$

Petri net models

Algebraic description of a Petri net

The resulting marking M' of the net after a firing sequence (transition that have been fired) is given by the state equation:

$$M' = M + C \sigma$$

where M is the marking before the firing sequence, C is the incidence matrix and σ is a vector that gives for each transition its number of occurrences.

In our example, the firing sequence is t_1 and t_2 :

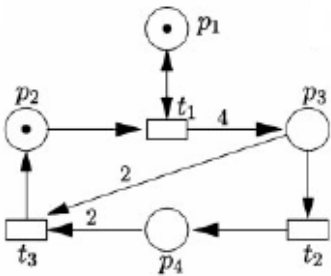

Initial marking M_0

t_1 and t_2 have been fired

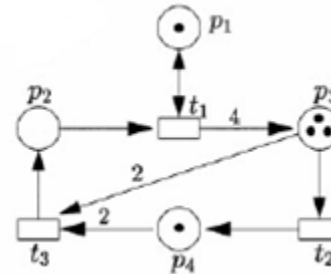

Resulting marking M_2

$$M_2 = M_0 + C \sigma$$

$$\sigma = \begin{bmatrix} 1 \\ 1 \\ 0 \end{bmatrix}$$

$$M_2 = \begin{bmatrix} 1 \\ 1 \\ 0 \\ 0 \end{bmatrix} + \begin{bmatrix} 0 & 0 & 0 \\ -1 & 0 & 1 \\ 4 & -1 & -2 \\ 0 & 1 & -2 \end{bmatrix} \begin{bmatrix} 1 \\ 1 \\ 0 \end{bmatrix} = \begin{bmatrix} 1 \\ 1 \\ 0 \\ 0 \end{bmatrix} + \begin{bmatrix} 0 \\ -1 \\ 3 \\ 1 \end{bmatrix} = \begin{bmatrix} 1 \\ 0 \\ 3 \\ 1 \end{bmatrix}$$

Petri net models

Marking of the net after firing t_1 and t_2 :

$$M_2 = \begin{bmatrix} 1 \\ 0 \\ 3 \\ 1 \end{bmatrix}$$

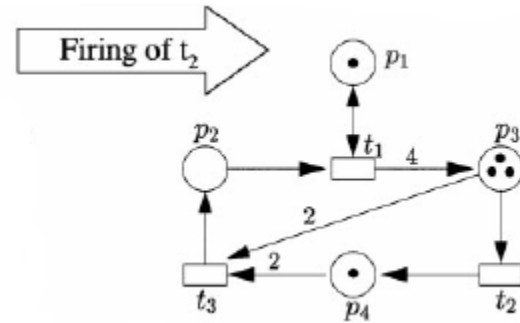

The marking graph: described the dynamical behavior from an initial marking, denoted $R(M_0)$

$R(M_0)$, the marking graph

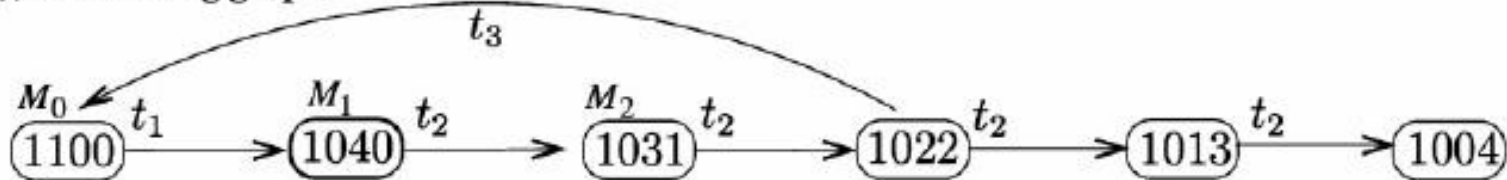

Example from Chaouiya ,2007

Standard Petri nets are discrete and non-temporized (time is implicit, the marking graph accounts for the possible sequence events).

Petri net models

Formal definition: A standard Petri net is a quadruple $N = (P, T, f, m_0)$, where:

P, T are finite, non-empty, disjoint sets. P is the set of places. T is the set of transitions.

An arc connects either a place to a transition or a transition to a place. If, F is the set of arcs

$F \subseteq (P \times T) \cup (T \times P)$.

$f: ((P \times T) \cup (T \times P)) \rightarrow \mathbb{N}$ defines the set of directed arcs, weighted by non-negative integer values.

f is a mapping that assigns a weight to an arc.

$m_0: P \rightarrow \mathbb{N}_0$ gives the initial marking.

Notations:

$m(p)$ refers to the number of tokens on place p in the marking m . A place p is clean (empty, unmark) in m if $m(p) = 0$.

A set of places is called clean if all places are clean, otherwise it is marked.

The preset and postset of a node $x \in P \cup T$ and are defined as:

Preset: $\bullet x := \{y \in P \cup T \mid f(y, x) \neq 0\}$

Postset: $x \bullet := \{y \in P \cup T \mid f(x, y) \neq 0\}$

For places and transitions, four types of sets:

$\bullet t$ preplaces of transition t (reaction's precursor)

$t \bullet$ postplaces of transition t (reaction's products)

$\bullet p$ pretransitions of place p (all producing reactions of a component)

$p \bullet$ posttransitions of place p (all consuming reactions of a component)

Generalized to a set of nodes X :

set of prenodes: $\bullet X := \cup_{x \in X} \bullet x$

set of postnodes: $X \bullet := \cup_{x \in X} x \bullet$

Petri net models

Definition : Firing Rule

Let $N = (P, T, f, m_0)$ be a Petri net:

- A transition t is enabled in marking m , written as $m|t\rangle$, if $\forall p \in \bullet t : m(p) \geq f(p,t)$, else it is disabled.
- A transition t , which is enabled in m , may fire.
- When t in m fires, a new marking m' is reached, written as $m|t\rangle m'$, with $\forall p \in P$:
$$m'(p) = m(p) - f(p,t) + f(t,p)$$
- The firing happens atomically and does not consume any time.

Petri net structural properties

Structural properties depend only on the arrangement of places, transitions and arcs. They characterize the network structure and are independent of the marking.

Initial model checking to prove that the model adheres to the assumption and modeling guideline.

Property		Informal Definition	Biological Meaning
PUR	Pure	There are no two nodes, directly connected in both directions. This precludes read arcs and double arcs.	No component is produced and consumed by the same reaction. Thus, enzymatic or enzyme-like reactions are formulated in more detail.
ORD	Ordinary	All arc weights are equal to 1.	Every stoichiometric coefficient of each reaction is equal to one.
HOM	Homogeneous	All outgoing arcs of a given place have the same multiplicity.	Each consuming reaction associated with one component takes the same amount of molecules of this component.
CON	Connected	A Petri net is connected if it holds for every two nodes a and b that there is an undirected path between a and b. Disconnected parts of a Petri net can not influence each other, so they can be usually analysed separately. In the following we only consider connected Petri nets.	All components in a system are directly or indirectly connected with each other through a set of reactions, e.g., metabolic paths, signal flows.
SC	Strongly Connected	A Petri net is strongly connected if it holds for every two nodes a and b that there is a directed path from a to b, vice versa. Strong connectedness involves connectedness and the absence of boundary nodes. It is a necessary condition for a Petri net to be live and bounded at the same time.	All components in a system are directly connected with each other through a set of reactions, e.g., metabolic paths, signal flows.
NBM	Non-blocking Multiplicity	The minimum of the multiplicity of the incoming arcs for a place is not less than the maximum of the multiplicities of its outgoing arcs.	The amount of produced and consumed molecules of a certain component is always equal.

Extract from Tutorial Snoopy, 2011,
M. A. Blätke

Petri net structural properties

CSV	Conservative	All transitions add exactly as many tokens to their post-places as they subtract from their pre-places (token-preservingly firing). A conservative Petri net is structurally bounded.	The total amount of consumed and produced molecules by a certain reaction is always equal.
SCF	Static conflict free	There are no two transitions sharing a pre-place. Transitions involved in a dynamic conflict compete for the tokens on shared places.	For every reactant exist just one possible reaction or there are no two reactions sharing at least one reactant.
FT0	No input transition	There exist no transitions without pre-places.	Infinite source of a component.
TF0	No output transition	There exist no transitions without post-places.	Sink of a component.
FP0	No input place	There exist no places without pre-transitions.	The component can not be produced by any reaction. Thus, such components are limiting.
PF0	No output place	There exist no places without post-transitions	Components can infinitely accumulate in the system. Thus, they are not consumed by any reaction.

Petri net qualitative properties

Typical net dynamical properties can be checked. They characterize the system behavior of a model, which depend on the qualitative network and on the initial marking. They are independent of the time-dependent dynamic behavior and thus independent of kinetic information.

- **Boundedness:** For every place it holds that whatever happens, the maximum number of tokens on this place is bounded by a constant. It insures that, whatever the initial marking and the evolution of the net, the number of tokens in each place is bounded, *i.e.* limited. For metabolic networks, it means that no product can accumulate.
- **Liveness:** For every transition it holds that whatever happens, it will always possible to reach a state where this transition gets enabled. In a live net, all transitions (biological processes and reactions) are able to contribute to the net behavior forever, which precludes dead states. A dead state is a state where none of the transitions are enabled.
- **Reversibility:** For every state it holds that whatever happens the net will always be able to reach this state again. In biology, it means that the initial state of a system can be reproduced by any possible state reached from the initial condition.

Petri net qualitative properties

Boundedness

Property		Informal Definition	Biological Meaning
SB	Structurally bounded	A Petri net is structurally bounded if it is bounded in any initial marking.	It is not possible that any component accumulates in the system independent of the initial conditions.
1-B	1-bounded	A Petri net is 1-bounded if all its places are 1-bounded.	Number of molecules or the concentration of every component is limited to one only.
k-B	k-bounded	A Petri net is k-bounded if all its places are k-bounded.	Number of molecules or the concentration level of each component is limited to a constant number k.

1-bounded Petri nets are called **safe network**

Extract from Tutorial Snoopy, 2011, M. A. Blätke

Formal definition:

- A place p is k -bounded if there exists a positive integer number k , which represents an upper bound for the number of tokens on this place in all reachable markings of the Petri net:

$$\exists k \in \mathbb{N}_0 : \forall m \in |m_0\rangle : m(p) \leq k$$

- A Petri net is k -bounded if all its places are k -bounded.
- A Petri net is structurally bounded if it is bounded in any initial marking.

Petri net qualitative properties

Liveness

Formal definition:

- A transition t is dead in the marking m if it is not enabled in any marking m' reachable from:
 $\nexists m' \in |m\rangle : m'(t)$
- A transition t is live, if it is not dead in any marking reachable from m_0 .
- A marking m is dead, if there is no transition which is enabled in m .
- A Petri net is deadstate-free, if there are no reachable dead markings.
- A Petri net is live, if each transition is live.

Reversibility

Formal definition:

A Petri net is reversible if the initial marking can be reached again from each reachable marking:

$$\forall m \in |m_0\rangle : m_0 \in |m\rangle$$

Petri net qualitative properties

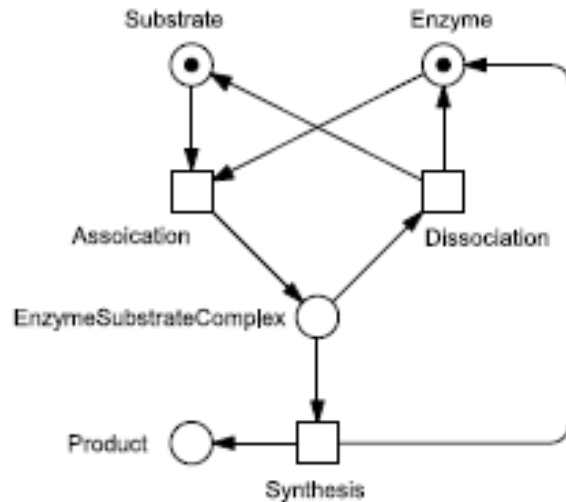

Reachable markings starting from initial marking m_0 by playing the token game

Place	m_0	m_1	m_2
Enzyme	1	0	1
Substrate	1	0	0
Complex	0	1	0
Product	0	0	1

Extract from Tutorial Snoopy, 2011, M. A. Blätke

- Each place has an upper bound k equal to 1.
- All place are 1-bounded, thus the resulting Petri net is 1-bounded
- Marking m_2 is dead, none of the translation can be enabled
- The Petri net has a deadstate because of m_2
- The Petri net is not live because all transitions are not live
- The Petri net is not reversible because the initial state m_0 can not be reached from marking m_2

Petri net qualitative properties

Important structural motifs of Petri net:

- Traps
- Siphons
- Invariants

Trap:

A trap is a subnet that catches tokens and retain at least one of them. The number of tokens in a trap can decreased but never reached zero. It is a state of places such that every transition that inputs from these places also outputs from one of these places. Once marked a trap remains marked.

Cyclic structures in a biological system that are activated by an input should be represented in a model as a trap.

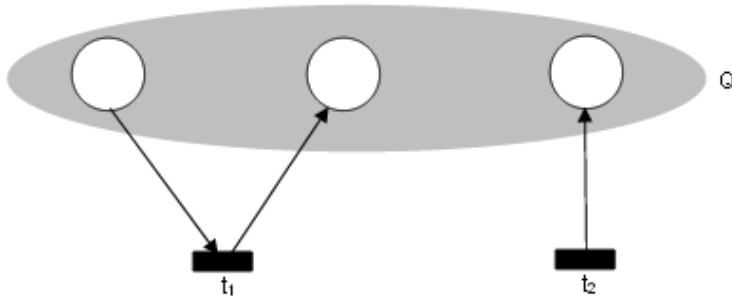
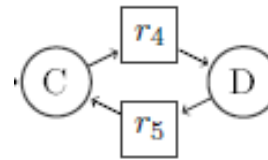

Definition

A set of places $Q \subseteq P$ is called trap if $Q \bullet \subseteq \bullet Q$ (the set of post-transitions is contained in set of pre-transitions), *i.e.*, every transition which subtracts tokens from a place of the trap, also has a post-place in this set.

$Q \bullet = \{t_1\}$ et $\bullet Q = \{t_1, t_2\}$ thus $Q \bullet \subseteq \bullet Q$

Token count in this trap remains the same by firing t_1 but increases by firing t_2

Petri net qualitative properties

Siphon:

A siphon is a subnet that releases all its tokens. A Petri net without siphons is live while a system in a dead state has a clean siphon. In biological terms, a siphon is a finite source of molecules or energy. It could also be a cycle that might produce molecules by consuming itself.

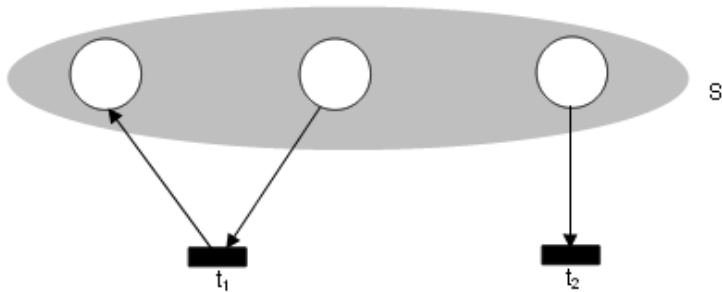

Definition

A non-empty set of places $D \subseteq P$ is called siphon if $\bullet D \subseteq D \bullet$ (the set of pre-transitions is contained in set of post-transitions), *i.e.*, every transition which fires tokens onto a place in the siphon, also has a pre-place in this set.

$\bullet D = \{t_1\}$ et $D \bullet = \{t_1, t_2\}$ thus $\bullet D \subseteq D \bullet$

Token count in this siphon remains the same by firing t_1 but decreases by firing t_2

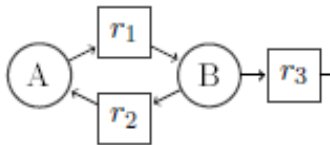

$\bullet D = \{r_1, r_2\}$ et $D \bullet = \{r_1, r_2\}$ thus $\bullet D \subseteq D \bullet$

Transitions r_1 and r_2 , which remove a token from A or B, can add a token to A or B. However, once they are empty of tokens, the places will never regain tokens.

Petri net qualitative properties

Summary

Properties	Trap	Siphon
Behavioral property	By definition, once a place in a trap has a token, there will always be a token in at least one of the places in the trap. Hence, a trap having at least one token can never lose all of its tokens. In other words, if a trap is marked under some marking, it remains marked under each successor marking.	By definition, once all places in a siphon have no token, there will never be a token in any one of the places in the siphon. Hence, a siphon having lost all of its tokens can never obtain a token again. In other words, if a siphon is token-free under some marking, then it remains token-free under each successor marking.
Union	Union of two traps is again a trap [2].	Union of two siphons is again a siphon [2].

Petri net qualitative properties

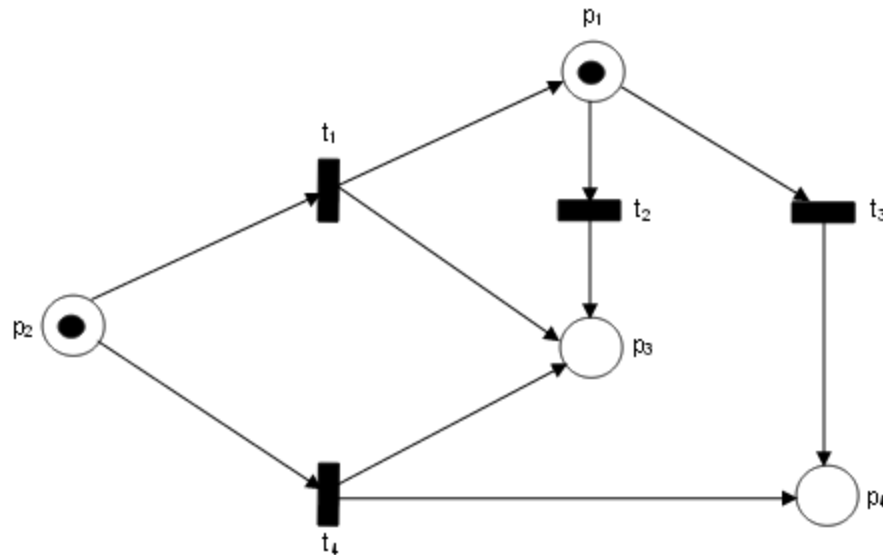

Set of places :

$$S_1 = \{p_1, p_2, p_3\}$$

$$S_2 = \{p_1, p_2, p_4\}$$

$$S_4 = \{p_2, p_3\}$$

$$S_5 = \{p_2, p_3, p_4\}$$

$$S_3 = \{p_1, p_2, p_3, p_4\}$$

Among these different sets of places which one are traps and/or siphons ?

Petri net qualitative properties

Invariants:

In Petri net context, invariants indicate states in the net graph that are not changed after a transformation or a sequence of transformations. We can distinguish two types of invariants, place invariants and transition invariants.

P-invariants (place invariants): it is a set of places over which the weighted sum of tokens is constant and independent of any firing. Thus a P-invariant conserves the number of tokens. Then each place of a P-invariant is bounded. In the biological context, P-invariant can assure mass conservation and avoid an infinite increase of molecules in the model.

A vector of places is called P-invariant if it is a non-trivial non-negative integer solution of the linear equation system $x^T \cdot C = 0$ (C incidence matrix)

Petri net qualitative properties

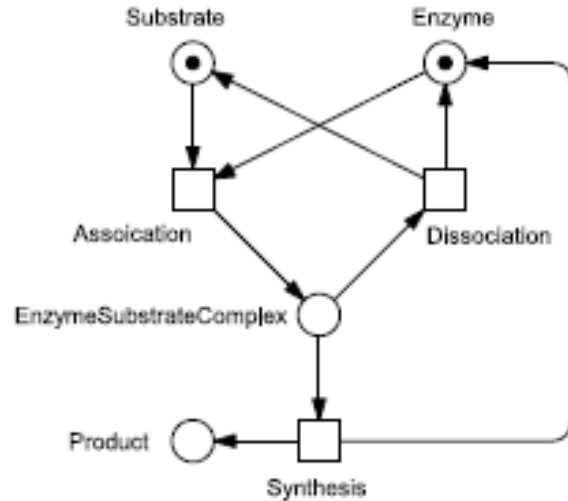

Incidence matrix (Post – Pre)

	<i>Association</i>	<i>Dissociation</i>	<i>Synthesis</i>
Enzyme	-1	1	1
Substrate	-1	1	0
Complex	1	-1	-1
Product	0	0	1

Pre-condition matrix

	<i>Association</i>	<i>Dissociation</i>	<i>Synthesis</i>
Enzyme	1	0	0
Substrate	1	0	0
Complex	0	1	1
Product	0	0	0

Post-condition matrix

	<i>Association</i>	<i>Dissociation</i>	<i>Synthesis</i>
Enzyme	0	1	1
Substrate	0	1	0
Complex	1	0	0
Product	0	0	1

Petri net qualitative properties

Incidence matrix (Post – Pre)

	<i>Association</i>	<i>Dissociation</i>	<i>Synthesis</i>
Enzyme	-1	1	1
Substrate	-1	1	0
Complex	1	-1	-1
Product	0	0	0

Vector x of places: $x = \begin{pmatrix} x_1 \\ x_2 \\ x_3 \\ x_4 \end{pmatrix}$

Solution of $x^T \cdot C = 0$

$$(x_1 \ x_2 \ x_3 \ x_4) \begin{pmatrix} -1 & 1 & 1 \\ -1 & 1 & 0 \\ 1 & -1 & -1 \\ 0 & 0 & 0 \end{pmatrix} = 0 \quad \Rightarrow \quad \begin{array}{l} -x_1 - x_2 + x_3 = 0 \\ x_1 + x_2 - x_3 = 0 \\ x_1 - x_3 + x_4 = 0 \end{array} \quad \Rightarrow \quad \begin{array}{l} x_1 + x_2 = x_3 \\ x_2 = x_4 \end{array}$$

2 solutions : P-invariant 1 $x = (1, 0, 1, 0)$ {Enzyme; EnzymeSubstrateComplex}
 P-invariant 2 $x = (0, 1, 1, 1)$ {Substrate; EnzymeSubstrateComplex ; Product}

Each place is contained in at least one of the two P-invariants. Thus, the Petri net of our example is covered by P-invariants.

Petri net qualitative properties

T-invariant: it is a sequence of transition σ that reproduce an initial state, which enabled the firing of the transitions in the T-invariant. In the biological context, T-invariants ensure that the model of biological system can reinitialize a certain initial state. Firing the transitions of a T-invariant leads to a steady state behavior.

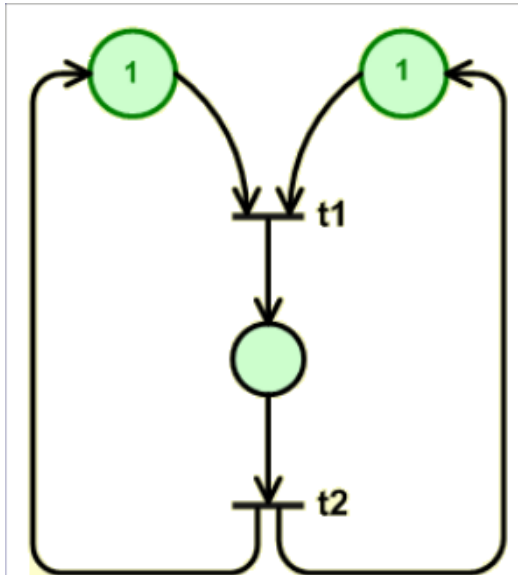

Example: after firing t_1 and t_2 the marking will be the same

A vector of transition is called T-invariant if it is a non trivial non-negative integer solution of the linear equation system $C \cdot y = 0$ (C incidence matrix)

Petri net qualitative properties

Incidence matrix (Post – Pre)

	<i>Association</i>	<i>Dissociation</i>	<i>Synthesis</i>
Enzyme	-1	1	1
Substrate	-1	1	0
Complex	1	-1	-1
Product	0	0	1

Transition vector y of places: $y = \begin{pmatrix} y_1 \\ y_2 \\ y_3 \end{pmatrix}$

Solution of $C \cdot y = 0$

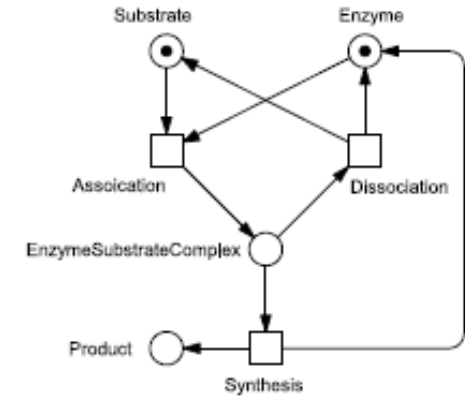

$$\begin{pmatrix} -1 & 1 & 1 \\ -1 & 1 & 0 \\ 1 & -1 & -1 \\ 0 & 0 & 1 \end{pmatrix} \begin{pmatrix} y_1 \\ y_2 \\ y_3 \end{pmatrix} = 0 \quad \Rightarrow \quad \begin{aligned} -y_1 + y_2 + y_3 &= 0 \\ -y_1 + y_2 &= 0 \\ y_1 - y_2 - y_3 &= 0 \\ y_3 &= 0 \end{aligned} \quad \Rightarrow \quad \begin{aligned} y_1 &= y_2 \\ y_3 &= 0 \end{aligned}$$

Only one solution: $y = (1, 1, 0)$

T-Invariant 1 : {Association, Dissociation}

As the transition Synthesis is not contained in the T-invariant, the Petri net is not covered by T-invariants

Petri net and genetic regulatory network : an example

Analysis of the phage shock protein stress response in *Escherichia Coli* : The Psp response that responds to alterations in the bacterial cell envelope (Toni *et al.*, BMC Systems Biology, 5: 69)

Biological knowledge :

- the *psp* genes in *E. coli* form the PspF regulon which includes the *psp* operon (*pspA*, *pspB*, *pspC*, *pspD* and *pspE* genes), *pspF* and *pspG* genes.

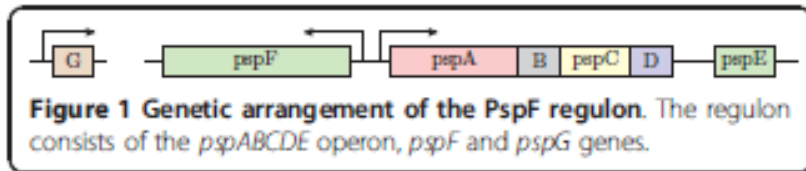

PspF is a transcription factor that activates the transcription of the *pspA-E* operon (σ^{54} promoter) and *pspG*. The gene *pspF* is transcribed via a σ^{70} promoter.

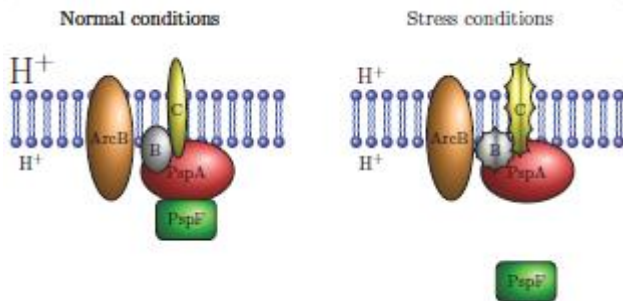

Under no stress condition PspA binds PspF which inhibits PspF ATPase activity. Thus the transcription of *pspA-E* operon and *pspG* is basal.

Under stress condition, a stimulus is converted into a signal that is transduced through PspB and PspC. This signal disrupts the PspA-PspF interaction and allows PspF to activate the transcription leading to the increase of concentration of several Psp Proteins.

Petri net and genetic regulatory network: an example

Known roles of Psp proteins :

- PspA, PspD and PspG play a major role in switching cell metabolism to anaerobic respiration and fermentation
- PspA and PspD are also involved in the repair of the damaged membrane
- PspA, PspD and PspG down-regulate cell motility which in turn down-regulate the consumption of the proton motive force and maintain the energy usage

Open questions upon the kinetics of signal transduction, function of Psp proteins and physiological responses like :

- how does the response evolve over time ?
- how quickly do cells respond to the stress when it is induced ?
- how quickly does the membrane get repaired ?
- how the system responds to the removal of stress ?

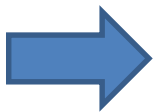

Modeling of the network of interactions in mathematical frameworks to analyze the system behavior and to interpret the results in terms of biological implications.

Petri net and genetic regulatory network: an example

Kinetic parameters are unknown → qualitative modeling

Construction of the model : assumptions and choices (what are the important biological elements that should be retained to capture the basic stress response dynamics) → construction of a simplified model.

PspD, PspE and PspG : known role : physiological response but not described yet as being involved in the response regulation: discarded of the network

Only PspA, PspB, PspC and PspF are retained. Moreover, PspB and PspC are represented as a complex BC.

Proteins involved in the transduction and amplification of the stress signal are not required to capture the basic response: not explicitly modeled.

Membrane : It can be intact or damaged when the stress acts on the membrane. To discretize the measurement of the damaged membrane, it will be modeled as consisting of the “intact membrane part” and the “damaged membrane part”. The damaged part will be expressed in percentage and this percentage will be translate into token number (maximum being 100)

Petri net and genetic regulatory network: an example

Petri net model construction

Places : Components of the system that should be taken into account

- stress
- damaged membrane (*dm*)
- intact membrane (*im*)
- PspA (*A*)
- PspB and PspC modeled as a complex (*BC*)
- BCA complex (*BCA*)
- BCAF complex (*BCAF*)
- BCA complex with conformational changes ($B_cC_cA_c$)
- PspF (*F*)
- Hexamer of PspF acting as transcription factor (*TF*)
- Oligomer of PspA (36 proteins) involved in the membrane repair (*olg*)

Petri net and genetic regulatory network: an example

Petri net model construction

Transitions: reactions between the system components that should be modeled

- stress + intact membrane \rightarrow stress + damaged membrane (tr_1)
- damaged membrane + PspA oligomer \rightarrow intact membrane + PspA oligomer (tr_2)
- 6 PspF \rightarrow transcriptional factor (tr_3)
- transcriptional factor \rightarrow 6 PspF (tr_4)
- transcription factor \rightarrow PspA (100) + complex BC (60 or 40) + transcription factor (tr_5)
- 36 PspA \rightarrow oligomer (tr_6)
- PspA + complex BC \rightarrow complex BCA (tr_7)
- complex BCA + PspF \rightarrow complex BCAF (tr_8)
- BCA + damaged membrane \rightarrow damaged membrane + complex $B_cC_cA_c$ (tr_9)
- intact membrane + complex $B_cC_cA_c$ \rightarrow intact membrane + complex BCA (tr_{10})
- damaged membrane + complex BCAF \rightarrow damaged membrane + PspF + complex $B_cC_cA_c$ (tr_{11})
- degradation de BCA (tr_{12})
- degradation de $B_cC_cA_c$ (tr_{13})
- degradation oligomer (tr_{14})
- degradation complex BC (tr_{15})
- degradation PspA (tr_{16})

The number of proteins have been deduced from the experimental ratio measured for mRNA production of PspA, PspB and PspC (100:60:40) . As BC was modeled 60 has been chosen but it could also be 40. One part of produced PspA complexes with BC and this other part forms the oligomer by binding 36 proteins into a complex.

Petri net and genetic regulatory network: an example

Petri net model construction

Assumptions:

- once PspA forms a complex with PspB and PspC, it cannot be used anymore to form the oligomer. PspA is never released from the complex BCA.
- no threshold for the percentage of damaged membrane in order to pass the signal. The signal will be stronger if a larger part of the membrane is damaged (more tokens in *dm*) and weaker for a less portion of damaged membrane
- thus, rate of BCA_F break-down and rate of BCA conformational change will be proportional to the percentage of damaged membrane.
- number of PspF and related constructs (ΣF , TF and BCA_F) is constant in cells. Therefore, production and degradation of PspF has been excluded from the model

Resulting Petri net model

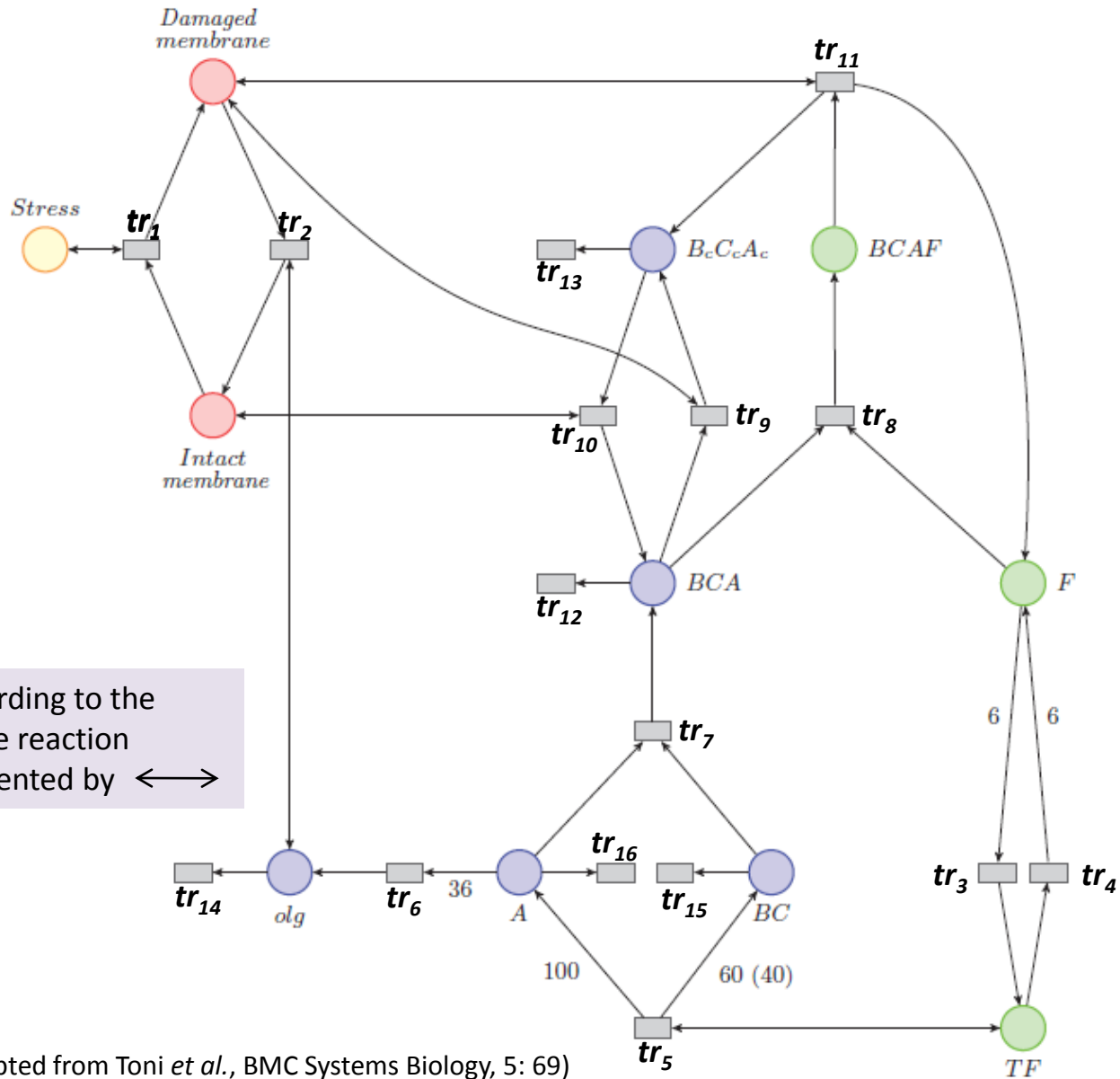

Weighted arcs according to the stoichiometry of the reaction
 Test arcs are represented by \longleftrightarrow

(adapted from Toni *et al.*, BMC Systems Biology, 5: 69)

Petri net and genetic regulatory network

Petri net model simplification: to avoid the estimation of a large number of unknown parameters

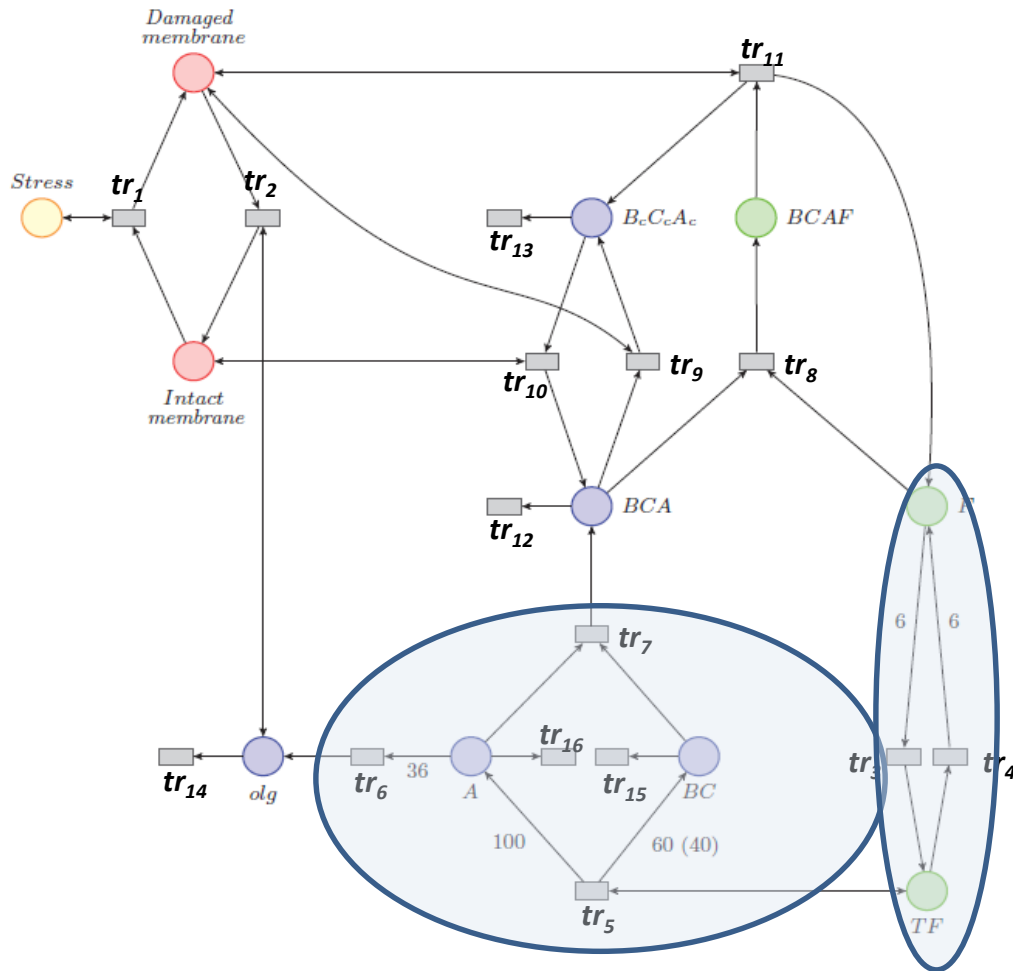

Modeling of BCA complex production simplified (production of A and BC not modeled)

Production of TF not modeled anymore

Complexes BCAF, BCA and $B_cC_cA_c$ are modeled as hexamer complexes in order to simplify the hexamer formation of the PspF complex which is the active form of TF.



tr_3, tr_4, tr_5 and tr_7 have been summarized by:



tr_{15} and tr_{16} (degradation of BC and A respectively) have been suppressed.

Resulting simplified Petri net model

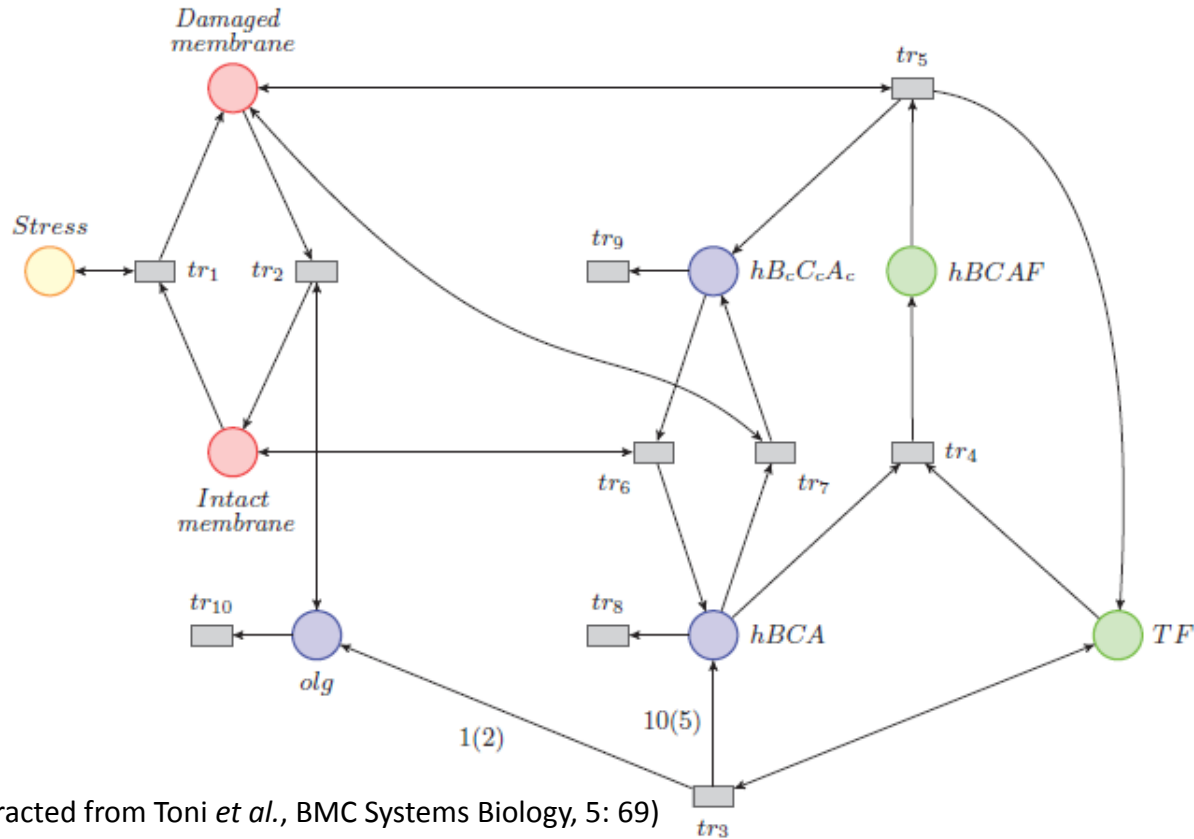

Initial marking : make sure that it will not lead to “deadlocks”, *i.e.*, no transitions can be fired anymore.
 Choice $M_0 = (\text{stress}, \text{dm}, \text{im}, \text{olg}, \text{hBCA}, \text{hBC}_{c_c}Ac, \text{hBCAF}, \text{TF}) = (1, 0, 100, 0, 0, 0, 20, 0)$

Petri net model: structural analysis

Qualitative validation of the basic model structure : P- and T-invariants determination

Table 1 P-invariants of the simplified Petri net Psp model

<i>Stress</i>	<i>dm</i>	<i>im</i>	<i>olg</i>	<i>hBCA</i>	<i>hB_cC_cA_c</i>	<i>hBCAF</i>	<i>TF</i>
1	0	0	0	0	0	0	0
0	1	1	0	0	0	0	0
0	0	0	0	0	0	1	1

P-invariants:

The numbers of tokens in *stress*, $dm + im$, $hBCAF + TF$ are constant. However, as some places (*hBCA*, *hB_cC_cA_c* and *olg*) don't belong to P-invariant, the network is not covered in P-invariants. In theory, it means that those places are not bounded. In practice, for this case it does not matter.

Table 2 T-invariants of the simplified Petri net Psp model

<i>tr₁</i>	<i>tr₂</i>	<i>tr₃</i>	<i>tr₄</i>	<i>tr₅</i>	<i>tr₆</i>	<i>tr₇</i>	<i>tr₈</i>	<i>tr₉</i>	<i>tr₁₀</i>
1	1	0	0	0	0	0	0	0	0
0	0	0	0	0	1	1	0	0	0
0	0	1	0	0	0	0	10	0	1
0	0	0	1	1	1	0	0	0	0
0	0	1	0	0	0	10	0	10	1
0	0	1	10	10	0	0	0	10	1

T-invariants:

Every transition belongs at least to a T-invariant. Thus, the network is covered in T-invariants, meaning that starting with a marking M the sequence of transitions will be bring back the system at this initial marking M .

Petri net models

Different types of Petri nets:

- **qualitative** Petri net: discrete space – level of molecules (number of tokens)
- **stochastic** Petri net: discrete space - transitions fire after a probabilistic delay determined by a random variable
- **continuous** Petri net: continuous space – ordinary differential equation for each place (concentration)
- **hybrid** Petri net: combines stochastic and continuous Petri nets features (example: reactions with low rates considered as stochastic and reactions with high rates considered as continuous)
- **coloured** Petri net: It allows the description of repeated interactions within a spatial context.